



Coral



Coral

Coral Pendant is based on one of the geometric polyhedra that have interested David since he was a boy. The intricate form is made from just one single component repeated 60 times. Originally designed purely as an experiment, it only became a light later when David tried to find a use for it by putting a bulb inside.

Coral is available in various sizes to suit any space. The plywood finish can be either raw bamboo or painted, offering a range of options.

Coral was David's first lighting design which now is considered to be a design classic.



Features

Shipped Kitset

Seed System kitset lightshades are on average 1/30th of the volume of the assembled light. This aims to help minimize the effects of shipping and to reduce the design's environmental footprint.

Warranty

This light is warranted for three years from date of purchase for failure of parts.

Care Instructions

All lights are intended for use in dry interior conditions only and can be cleaned with a soft cloth dampened slightly in warm water when the light is switched off. Do not use detergents.

EPD Certified

An EPD is a standardised and verified way of quantifying the environmental impacts of a product, based on a consistent set of rules that have been developed through a stakeholder consultation process.



Compliance



CE



AS/NZS

(Declarations of conformity available on request).



Coral
400mm (16")

Orange
1 Side

Bamboo



Technical Data

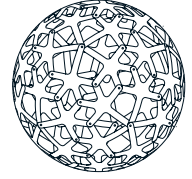
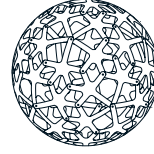
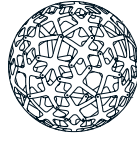
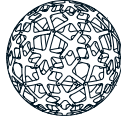
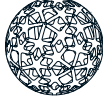

400mm/16"

600mm/24"

800mm/31"

1000mm/39"

1200mm/47"

1600mm/63"

Diameter: 400mm / 16"	Diameter: 600mm / 24"	Diameter: 800mm / 31"	Diameter: 1000mm / 39"	Diameter: 1200mm / 47"	Diameter: 1600mm / 63"
Weight: 0.4kg / 0.88lb	Weight: 1kg / 2.20lb	Weight: 1.5kg / 3.30lb	Weight: 2.3kg / 5.07lb	Weight: 3.8kg / 8.37lb	Weight: 9kg / 19.84lb
2m / 6.5ft	2m / 6.5ft	2m / 6.5ft	3m / 9.8ft	5m / 16.4ft	5m / 16.4ft
Bamboo plywood (Sourced from FSC accredited factory)	Bamboo plywood (Sourced from FSC accredited factory)	Bamboo plywood (Sourced from FSC accredited factory)	Bamboo plywood (Sourced from FSC accredited factory)	Bamboo plywood (Sourced from FSC accredited factory)	Bamboo plywood (Sourced from FSC accredited factory)
Nylon	Nylon	Nylon	Nylon	Nylon	Aluminium
Hangs on cord	Hangs on cord	Hangs on cord	1 x Suspension Wire	1 x Suspension Wire	1 x Suspension Wire
290mm x 170mm x 85mm 11" x 7" x 3" 0.004m ³ / 0.141ft ³ 0.7kg / 1.54lb	385mm x 215mm x 105mm 15" x 8" x 4" 0.009m ³ / 0.317ft ³ 1.4kg / 3.00lb	500mm x 280mm x 100mm 20" x 11" x 4" 0.014m ³ / 0.494ft ³ 2.3kg / 5.1lb	400mm x 310mm x 125mm 16" x 12" x 5" 0.016m ³ / 0.565ft ³ 3.2kg / 7.1lb	365mm x 425mm x 125mm 14" x 17" x 5" 0.019m ³ / 0.671ft ³ 4.2kg / 9.25lb	470mm x 395mm x 180mm 19" x 16" x 7" 0.33m ³ / 1.165ft ³ 9.5kg / 20.94lb

Dimensions

Cordset*

Material

Fasteners

Suspension

Packaging

*Black comes with black cordset and fasteners. All others come with white cordset and white fasteners. Custom lengths available on request.

Finishes

We offer 12 stock finish options for Coral. We use low VOC acrylic paint and it is most commonly used on the interior of the light. We can also produce lights in other finishes or colours by special order. All lights are made from sustainably grown bamboo plywood sourced from an FSC accredited factory.



Raw Finish

Bamboo

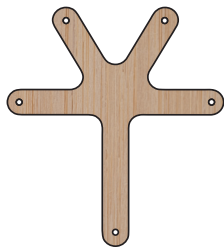

Painted 2 Sides

Black

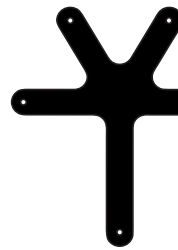

White

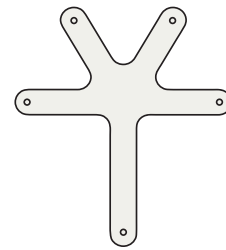

Painted 1 Side

Blue

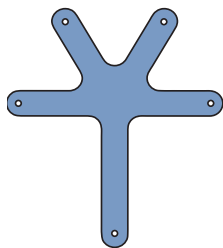

Aqua

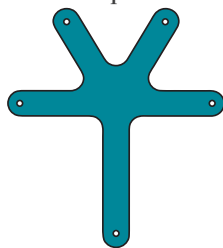

Lime

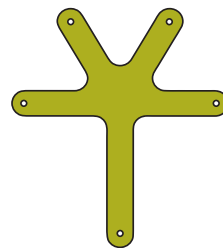

Orange

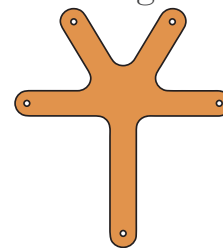

Pink

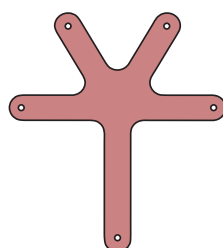

Red

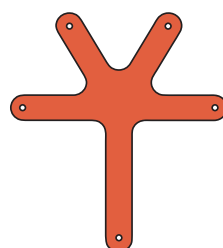

Black

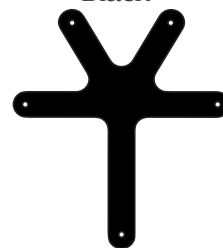

White

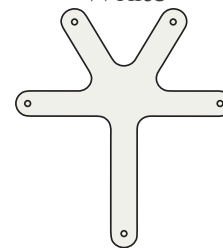



Bamboo

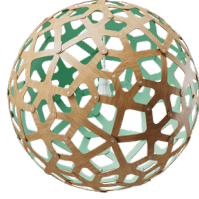

Aqua

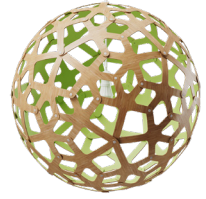

Lime

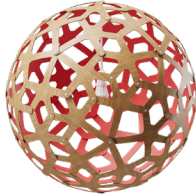

Red

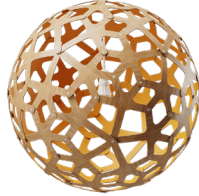

Orange

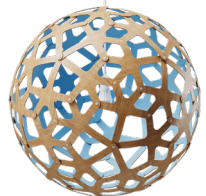

Blue

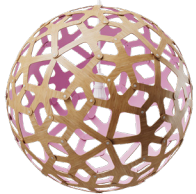

Pink

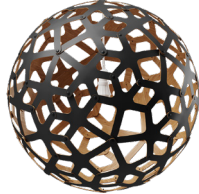

Black 1 Side (Outside)

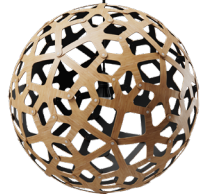

Black 1 Side (Inside)

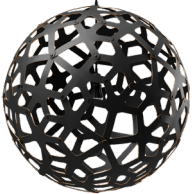

Black 2 Sides

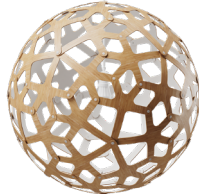

White 1 Side

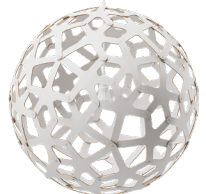

White 2 Sides

Electrics

400mm/16"

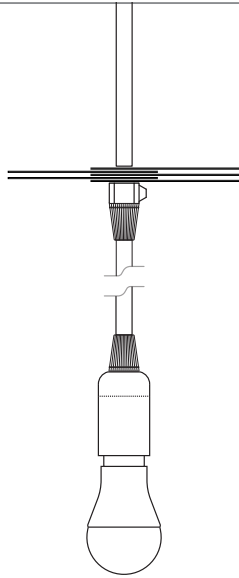

600mm/24"
800mm/31"

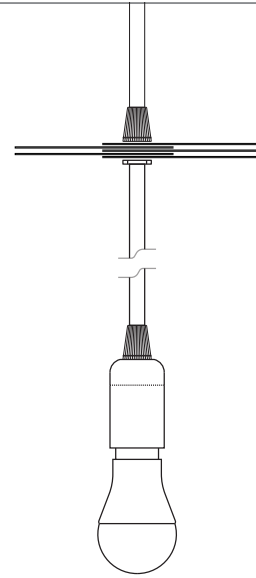

North America: E26,
Max 60 Watts 120v AC
60hz
Rest of World: E27,
Max 60 Watts
230-240v AC 50hz

North America: E26,
Max 60 Watts 120v
AC 60hz
Rest of World: E27,
Max 60 Watts
230-240v AC 50hz

1000mm/39"
1200mm/47"
1600mm/63"

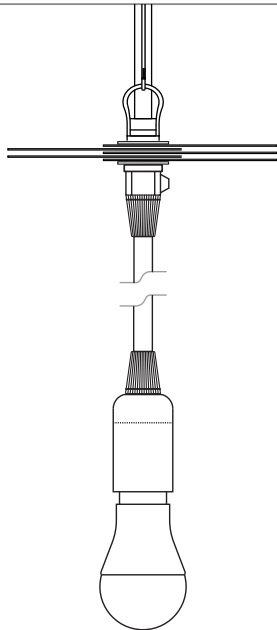

North America: E26,
Max 60 Watts 120v AC
60hz
Rest of World: E27,
Max 60 Watts
230-240v AC 50hz

Installation

1000mm/39"

1200mm/47"

1600mm/63"

Fixings for cone gripper (fixing screws NOT SUPPLIED).

Note: Choose appropriate hardware to attach base plate (Fig.1) to ceiling substrate.

6mm/ ¼" Ø max.



9mm/ ⅜" Ø max.

Fig 1. Base Plate

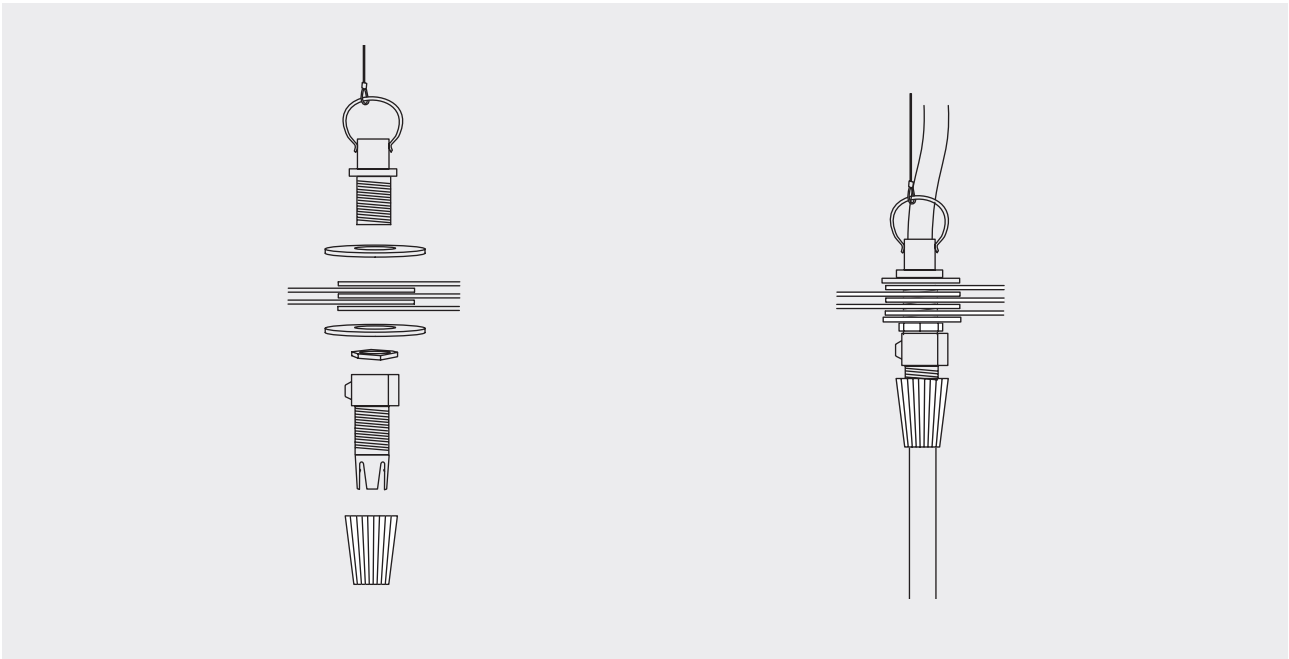

Step 1.

Follow the order of each component in diagram. Adjust the bulb / lamp to mid way in the pendant lightshade shown in Step 2 and then tighten.

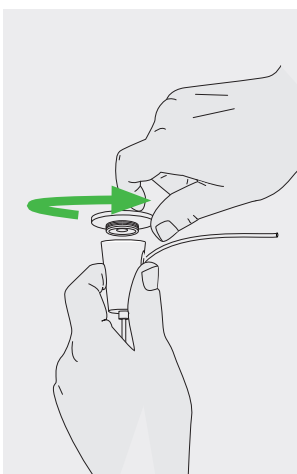

Step 2.

Unscrew baseplate.

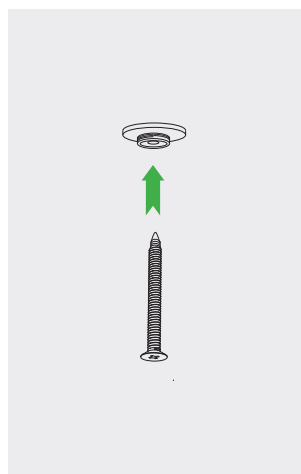

Step 3.

Use appropriate fixing screw to mount base plate (Fig.1).

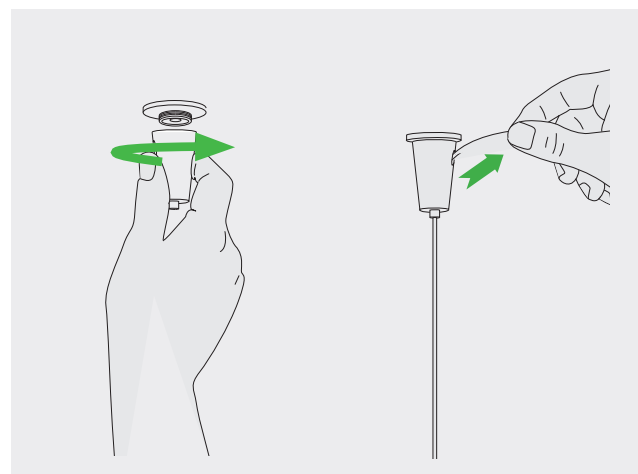

Step 4.

Remove cable from cone. Screw cone back onto baseplate. Re-insert cable and level light. Once desired position is set, trim excess cable.

) david
trubridge

davidtrubridge.com

David Trubridge Studio

Hawke's Bay, New Zealand

info@davidtrubridge.com

+64 6 650 0204

Certified



Corporation



sustainable
coastlines