



TO 12 TONS, MANCHESTER  
2

Floral



# Floral

---

Floral was designed three years after Coral light, based on geometric polyhedra forms. Floral was designed to offer a softer more decorative offering alongside Coral which is more structured.

Floral is available in various sizes to suit any space. The plywood finish can be either raw bamboo or painted, offering a range of options.



# Features

---

## Shipped Kitset

Seed System kitset lightshades are on average 1/30th of the volume of the assembled light. This aims to help minimize the effects of shipping and to reduce the design's environmental footprint.

## Warranty

This light is warranted for three years from date of purchase for failure of parts.

## Care Instructions

All lights are intended for use in dry interior conditions only and can be cleaned with a soft cloth dampened slightly in warm water when the light is switched off. Do not use detergents.

## EPD Certified

An EPD is a standardised and verified way of quantifying the environmental impacts of a product, based on a consistent set of rules that have been developed through a stakeholder consultation process.



## Compliance



CE



## AS/NZS

**(Declarations of conformity available on request).**

Floral  
600mm (24")

Bamboo

Pink  
1 slide





# Technical Data



**400mm/16"**

**600mm/24"**

**800mm/31"**

**1000mm/39"**

**1200mm/47"**

**1600mm/63"**

Diameter: 400mm / 16"	Diameter: 600mm / 24"	Diameter: 800mm / 31"	Diameter: 1000mm / 39"	Diameter: 1200mm / 47"	Diameter: 1600mm / 63"
Weight: 0.4kg / 0.88lb	Weight: 1kg / 2.20lb	Weight: 1.5kg / 3.30lb	Weight: 2.3kg / 5.07lb	Weight: 3.8kg / 8.37lb	Weight: 9kg / 19.84lb
2m / 6.5ft	2m / 6.5ft	2m / 6.5ft	3m / 9.8ft	5m / 16.4ft	5m / 16.4ft
Bamboo plywood (Sourced from FSC accredited factory)	Bamboo plywood (Sourced from FSC accredited factory)	Bamboo plywood (Sourced from FSC accredited factory)	Bamboo plywood (Sourced from FSC accredited factory)	Bamboo plywood (Sourced from FSC accredited factory)	Bamboo plywood (Sourced from FSC accredited factory)
Nylon	Nylon	Nylon	Nylon	Nylon	Aluminium
Hangs on cord	Hangs on cord	Hangs on cord	1x Suspension Wire	1x Suspension Wire	1x Suspension Wire
290mm x 170mm x 85mm 11" x 7" x 3"	385mm x 215mm x 105mm 15" x 8" x 4"	500mm x 280mm x 100mm 20" x 11" x 4"	400mm x 310mm x 125mm 16" x 12" x 5"	365mm x 425mm x 125mm 14" x 17" x 5"	470mm x 395mm x 180mm 19" x 16" x 7"
0.004m <sup>3</sup> / 0.141ft <sup>3</sup> 0.7kg / 1.54lb	0.009m <sup>3</sup> / 0.317ft <sup>3</sup> 1.4kg / 3.00lb	0.014m <sup>3</sup> / 0.494ft <sup>3</sup> 2.3kg / 5.1lb	0.016m <sup>3</sup> / 0.565ft <sup>3</sup> 3.2kg / 7.1lb	0.019m <sup>3</sup> / 0.671ft <sup>3</sup> 4.2kg / 9.25lb	0.033m <sup>3</sup> / 1.165ft <sup>3</sup> 9.5kg / 20.94lb

**Dimensions**

**Cordset\***

**Material**

**Fasteners**

**Suspension**

**Packaging**

\*Black comes with black cordset and fasteners. All others come with white cordset and white fasteners. Custom lengths available on request.

# Finishes

---

We offer 12 stock finish options for Floral. We use low VOC acrylic paint and it is most commonly used on the interior of the light. We can also produce lights in other finishes or colours by special order. All lights are made from sustainably grown bamboo plywood sourced from an FSC accredited factory.



Raw Finish

Bamboo

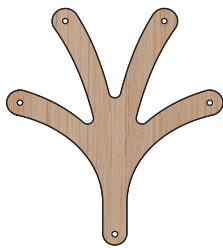

Painted 2 Sides

Black

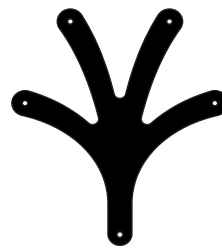

White

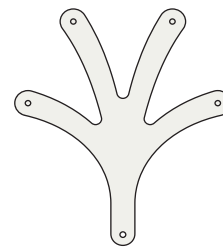

Painted 1 Side

Blue

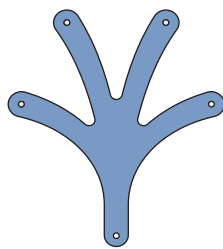

Aqua

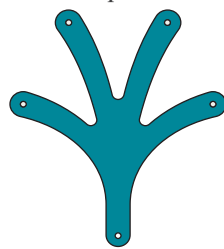

Lime

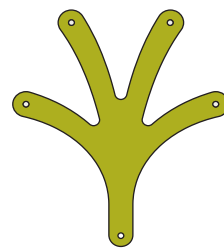

Orange

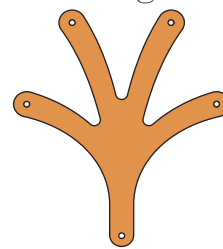

Pink

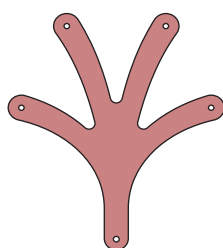

Red

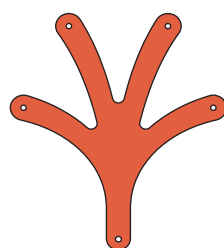

Black

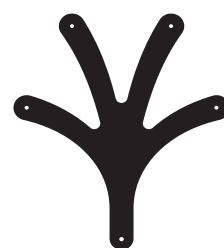

White

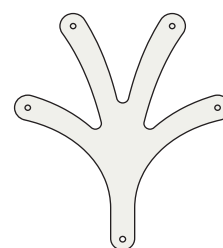





Bamboo



Aqua

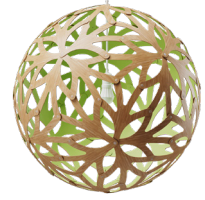

Lime



Red



Orange

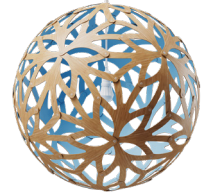

Blue



Pink



Black 1 Side (Outside)



Black 1 Side (Inside)

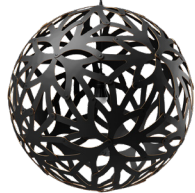

Black 2 Sides

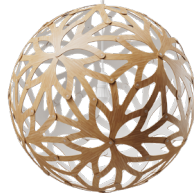

White 1 Side



White 2 Sides

# Electrics

400mm/16"

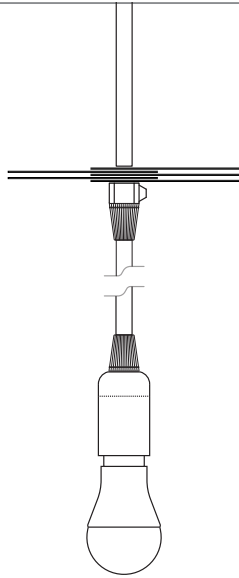

600mm/24"  
800mm/31"

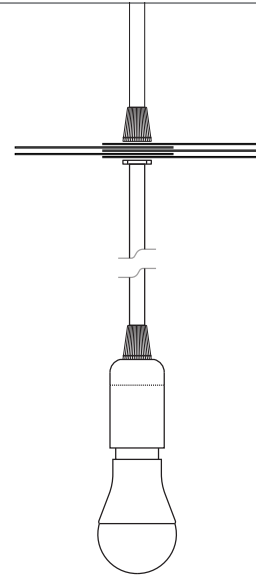

North America: E26,  
Max 60 Watts 120v AC  
60hz  
Rest of World: E27,  
Max 60 Watts  
230-240v AC 50hz

North America: E26,  
Max 60 Watts 120v  
AC 60hz  
Rest of World: E27,  
Max 60 Watts  
230-240v AC 50hz

1000mm/39"  
1200mm/47"  
1600mm/63"

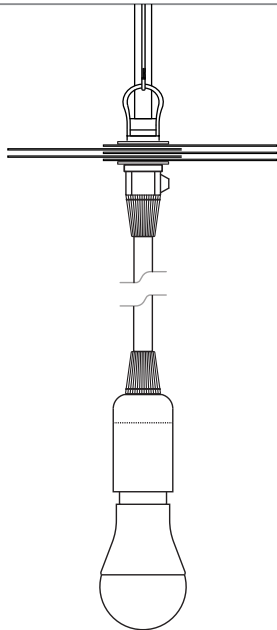

North America: E26,  
Max 60 Watts 120v AC  
60hz  
Rest of World: E27,  
Max 60 Watts  
230-240v AC 50hz

# Installation

1000mm/39"

1200mm/47"

1600mm/63"

Fixings for cone gripper (fixing screws NOT SUPPLIED).

Note: Choose appropriate hardware to attach base plate (Fig.1) to ceiling substrate.

6mm/ ¼" Ø max.



9mm/ ⅜" Ø max.

Fig 1. Base Plate

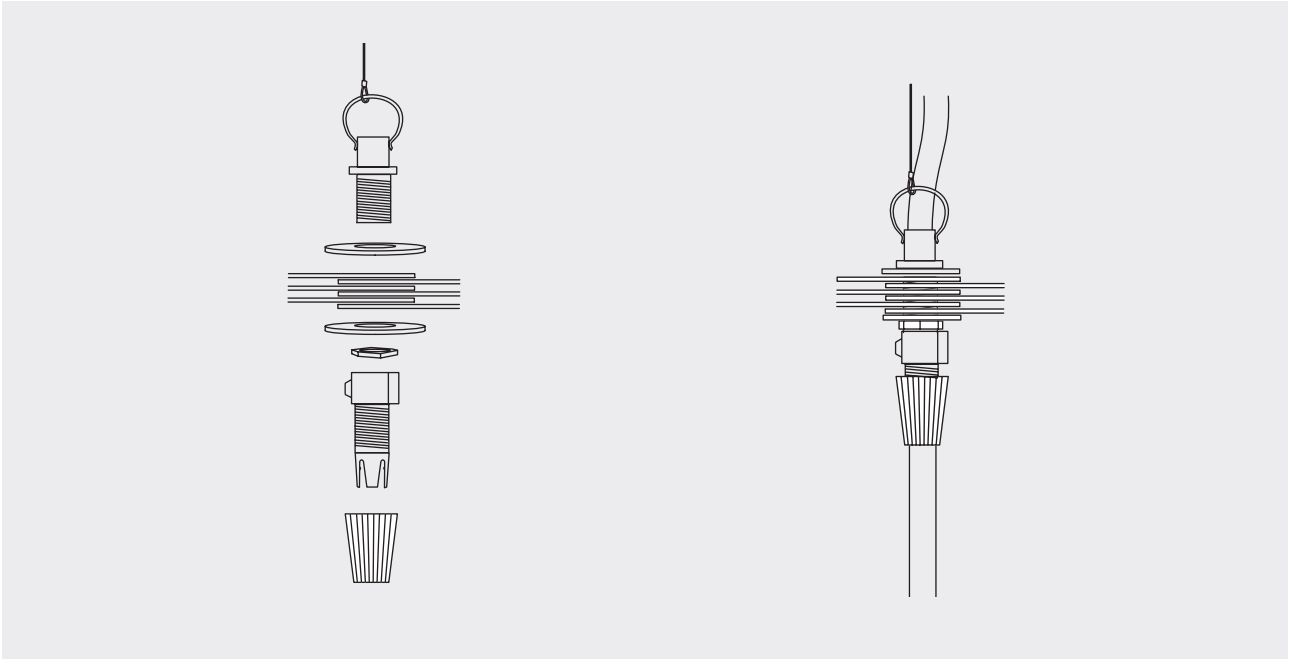

## Step 1.

Follow the order of each component in diagram. Adjust the bulb / lamp to mid way in the pendant lightshade shown in Step 2 and then tighten.

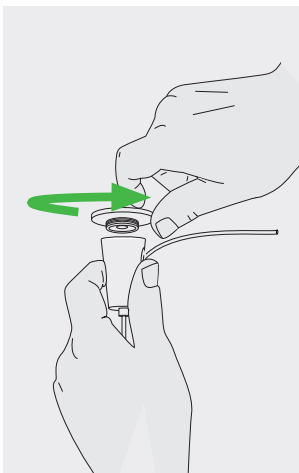

## Step 2.

Unscrew baseplate.

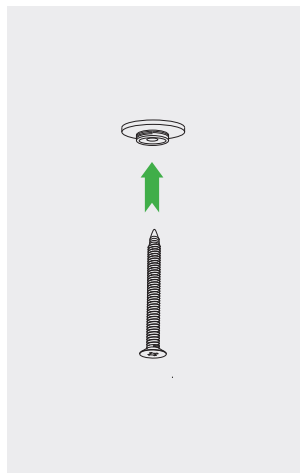

## Step 3.

Use appropriate fixing screw to mount base plate (Fig.1).

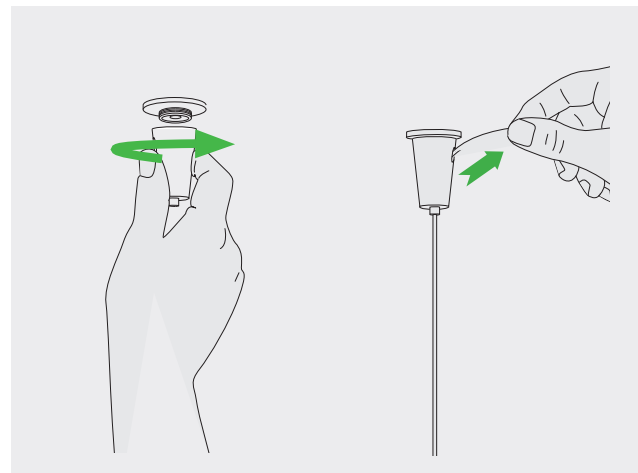

## Step 4.

Remove cable from cone. Screw cone back onto baseplate. Re-insert cable and level light. Once desired position is set, trim excess cable.

) david  
trubridge

[davidtrubridge.com](http://davidtrubridge.com)

David Trubridge Studio

Hawke's Bay, New Zealand

[info@davidtrubridge.com](mailto:info@davidtrubridge.com)

+64 6 650 0204

Certified



Corporation



sustainable  
coastlines